

Schematic diagram: SwimSkim 25 in use

Extras

Top 3 product characteristics

- Powerful suction cleaning of pond surfaces up to 25 m²
- Integrated aerator function for oxygen supply
- Easy and convenient cleaning

Recommendation

The SwimSkim models offer a particularly high level of cleaning convenience thanks to easy basket removal.

SWIMSKIM 25

Floating for clear water surfaces

- Powerful suction cleaning of pond surfaces up to 25 m²
- The result is clearly improved water quality and viewing depth through direct removal of pollutants on the surface
- Integrated injector that enriches the pond with oxygen
- Easy cleaning thanks to convenient basket removal
- Automatic adjustment to any water level (from 40 cm water depth)
- Extremely strong suction thanks to patented flap technology

TECHNICAL DATA



		SwimSkim CWS 25
Dimensions (L x W x H)	mm	332 x 297 x 263
Rated voltage		220 – 240 V / 50 Hz
Power consumption	W	40
Power cable length	m	10.00
Net weight	kg	2.68
Filter volume	l	0.9
Pos. water level difference		Unlimited
Pump capacity max.	l/h	2500
Aerator function	l/h	300
Item no. (GB-Version)		50124
Item no.		57384





Extras

Top 3 product characteristics

- Powerful suction cleaning of pond surfaces up to 50 m²
- Including unique outlet and aerator function
- Easy cleaning thanks to convenient basket removal

Recommendation

The SwimSkim CWS can be fixed in place either on the pond floor or with the provided ground stakes and tethering line.



SWIMSKIM CWS

Floating skimmer with aerator function

- Powerful suction cleaning of pond surfaces up to 50 m²
- The result is clearly improved water quality and viewing depth through direct removal of pollutants on the surface
- Including unique outlet function for agitation of floor sedimentation
- Including aerator function for oxygen supply of the pond
- Extremely powerful and energy efficient
- Automatic adjustment to any water level (from 40 cm water depth)
- Extremely strong suction thanks to patented flap technology
- Easy cleaning thanks to convenient basket removal
- Ideal supplement for the OASE filter system FiltoMatic CWS

TECHNICAL DATA

		SwimSkim CWS CWS
Dimensions (L x W x H)	mm	450 x 400 x 390
Rated voltage		220 – 240 V / 50 Hz
Power consumption	W	45
Power cable length	m	10.00
Net weight	kg	4.54
Filter volume	l	4.5
Pos. water level difference		Unlimited
Pump capacity max.	l/h	3500
Aerator function	l/h	600
Item no.		50170





Extras

Top 3 product characteristics

- Powerful suction cleaning of pond surfaces up to 40 m²
- Adapts automatically to changes in the water level to 120 mm
- Effective supplement in the entire filter system

Recommendation

The AquaSkim is the ideal supplement for the filter pump AquaMax Eco Premium.

Schematic diagram: AquaSkim in use with filter and watercourse pump AquaMax Eco Premium

AQUASKIM

Variable, stationary and gravity fed skimmer for every occasion

- Powerful suction cleaning of pond surfaces up to 40 m²
- The result is clearly improved water quality and viewing depth through direct removal of pollutants on the surface
- Base with large-surface receptacle for rocks as ballast
- New: AquaSkim 20 now also allows use of the AquaMax Eco Premium models 4000–8000
- New: AquaSkim Gravity with high-quality DN 160/110 adapter, allows easy integration in DN 110 line systems
- Easy maintenance with easily accessible coarse debris basket
- Debris basket can also be taken out from a distance via grip hooks



TECHNICAL DATA

		NEW		NEW
		AquaSkim 20	AquaSkim 40	AquaSkim Gravity
Dimensions (Ø x H)	mm	350 x 800		190 x 260
Net weight	kg	1.60	1.82	1.14
Height adaptation	mm	320-550/550-800	300-530/530-800	–
Tube diameter	mm	80		110
Filter volume	l	1.2	1.4	
Pos. water level difference		100 mm	120 mm	
Pump capacity min.	l/h	4000	8000	
Pump capacity max.	l/h	8000	16000	
Connections, outlet		1", 1¼", 1½"		DN 110
Item no.		51236	56907	51237





Extras

Top 3 product characteristics

- Powerful suction cleaning of pond surfaces up to 50 m²
- Excellent accessibility at the edge of the pond
- Can be perfectly integrated in the pond landscape with a rock look cover

Recommendation

For the best possible result, surface skimmers should be installed on the side of the pond that is away from the wind.

BIO SYS SKIMMER +

Skimmer for installation on the pond edge

- Powerful suction cleaning of pond surfaces up to 50 m²
- Permanent installation directly at the edge of the pond
- Easy installation through flanging the unit onto the pond liner
- Convenient cleaning thanks to easy removal of the coarse debris
- Compensation of water level fluctuations up to 100 mm
- For operation with optionally available AquaMax Eco in integrated pump chamber
- Included in the scope of delivery: Cover in natural rock look

TECHNICAL DATA

		BioSys Skimmer +
Dimensions (L x W x H)	mm	580 x 400 x 450
Net weight	kg	5.32
Guarantee* ^G (+ request guarantee)	Years	3 + 2
Pos. water level difference	mm	100
Skimmer opening width	mm	220
Filter volume	l	12.0
Pond surface, max.	m ²	50
Pump capacity min.	l/h	6000
Pump capacity max.	l/h	16000
Connections, outlet		¾", 1", 1¼", 1½"
Item no.		57137





Schematic diagram: ProfiSkim 100 in use

Extras

Top 3 product characteristics

- Powerful suction cleaning of pond surfaces up to 80 m²
- Can be used with large filter systems and in shallow water zones
- Perfect dimensions for large quantities of water

Recommendation

Ensure that the skimmer is installed in a precisely horizontal position and confirm this with a spirit level. Place the skimmer in such a manner that you can execute maintenance tasks, such as emptying the basket conveniently.

PROFISKIM

The pro for the shallow water zone

- Powerful suction cleaning of pond surfaces up to 65 or 80 m²
- Ideal implementation in shallow water zones
- Optimal water routing for effective suction capacity
- Perfect supplement for filter systems in the gravity-fed, as well as the pump-fed system
- For pump-fed systems the suction effect can be more clearly detected than is the case in the gravity-fed system
- Large, easy-to-clean stainless steel basket
- Incl. debris basket with 8 mm mesh width. A debris basket with 2 mm mesh width is available for the ProfiSkim Premium on request



TECHNICAL DATA

Matching filter pumps starting on page 68

		ProfiSkim 100	ProfiSkim Premium
Dimensions (L x W)	mm	780 x 585	Ø 490
Net weight	kg	12.56	10
Guarantee* ^G (+ request guarantee)	Years	3 + 2	
Height adaptation		350 mm – 550 mm	350 mm – 450 mm
Connections, outlet		2", DN 110	2", DN 110
Rec. flow rate (pumped)	l/h	10000 – 30000	6000 – 16000
Rec. flow rate (gravitation)	l/h	10000 – 12500	6000 – 12500
Filter volume	l	12.0	7.0
Pond surface, max.	m ²	80	65
Item no.		57134	51185



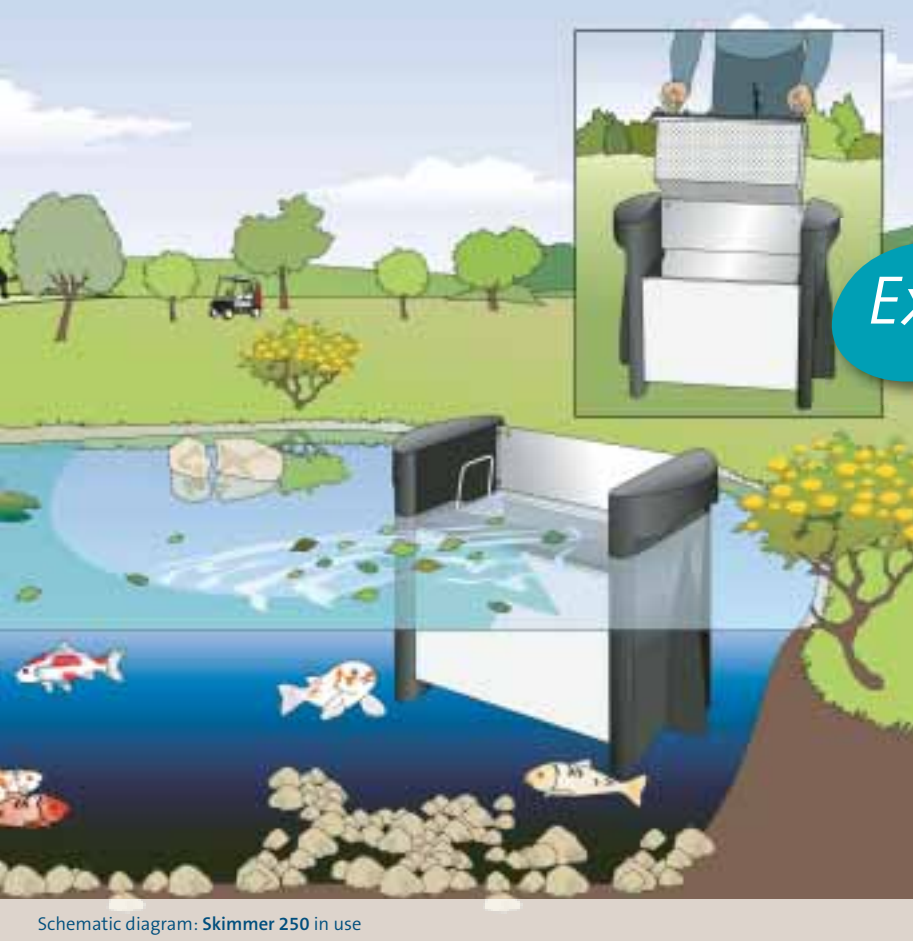

Schematic diagram: Skimmer 250 in use



Extras

Top 3 product characteristics

- Floating high-performance skimmer
- Robust, long service life
- 27-litre capacity in the stainless steel basket

Recommendation

Align the Skimmer 250 to the wind direction and flow of water in the pond/lake to achieve an optimal skimming result.

SKIMMER 250

Floating high performance skimmer

- Powerful suction cleaning of pond surfaces up to 250 m²
- Optimal adaptation to water level differences
- Special large inlet and powerful suction capacity for first-class skimming results
- Extremely long service life thanks to high-quality workmanship and stainless steel elements
- Large, 27-litre stainless steel pollutant collection basket
- Fastening material included in the scope of delivery

TECHNICAL DATA

		Skimmer 250
Dimensions (L x W x H)	mm	775 x 440 x 590
Rated voltage		220 – 240 V / 50 Hz
Power consumption	W	250
Power cable length	m	10.00
Net weight	kg	27.00
Guarantee*G	Years	2
Max. flow rate	l/min	250
Max. flow rate	l/h	15000
Connection, pressure-side		1 ½"
Filter volume	l	27.0
Skimmer opening width	mm	520
Pond surface, max.	m ²	250
Item no.		57480





PONDOVAC CLASSIC

Wet and dry vacuum for pond, and household



- Effective silt removal through powerful 1400 W motor
- Automatic activation and emptying through intelligent motor control
- Compact design with 27-litre wastewater tank
- High-power suction to a depth of 1.5 m
- With 4 different suction nozzles: Crevice nozzle, algae nozzle, flat nozzle with rubber lip and variable universal nozzle
- Included in the scope of delivery: 4 m suction hose and 2 m discharge hose

PRODUCT DETAILS



Accessories

With 4 suction tubes and 4 nozzles, one filter bag for dry vacuuming and a coarse debris collection sack.



Switch

Convenient, illuminated rocker switch for starting the vacuum process.



Plug connections

For fast installation of the suction and discharge hoses.



Quick-release

For easy opening of the motor unit.

TECHNICAL DATA

		PondoVac Classic
Dimensions (L x W x H)	mm	370 x 370 x 580
Rated voltage		220–240 V / 50 Hz
Power consumption	W	1400
Power cable length	m	4.00
Net weight	kg	9.50
Guarantee* ^G	Years	2.00
Suction depth max.	m	2.00
Length, suction hose	m	4.00
Length discharge hose	m	2.00
Item no. (GB-Version)		50110
Item no.		50529



Extras

Top 3 product characteristics

- Multifunction use for pond, pool, and household
- Maximum suction depth of 2 m
- Complete with extensive range of accessories

Included in the scope of delivery

Universal nozzle

The all-round talent (2 – 10 mm) reliably removes pond floor debris, without vacuuming up gravel.



Special string algae nozzle

With this nozzle, strands of string algae can be separated and very easily removed.



Flat nozzle

The flat nozzle has rubber lips that permit trouble-free wet suctioning of residual water, or enables use in the household as a dry vacuum.



Crevice nozzle

Pollutants between stones and plants can be suctioned out with ease.



Wastewater discharge

Simply dispose of it as »organic fertiliser« in a flower bed or the sewer.



Accessories

Extension discharge set PondoVac

2.5 m hose with connection union and collection bag for coarse debris particles. Not suitable for pond silt!

Item no. 55448





PONDovac 4

*Convenient and effective –
fast and effective pond cleaning*



PRO

- Vacuum non-stop thanks to the patented two-chamber system – simultaneous vacuuming and emptying of the tank
- Maximum suction depth of 2.4 m thanks to high-performance 1700 W motor with optimised blade geometry
- Can be used for cleaning garden ponds, pools and swim ponds, as well as a wet vacuum in the household
- Extensive suction depth of up to 2.4 m
- Transparent suction tube for flow-through control
- Easy to move with transport rollers and adjustable handle
- Hand regulator for adjusting the suction power
- Included in the scope of delivery: 4 robust aluminium tubes, special string algae nozzle, broadened universal nozzle, wet suction brush, brush nozzle, debris collection bag, 5 m long suction hose and 2.5 long discharge hose

PRODUCT DETAILS



Two-chamber system

Two same-size cylinders are filled and emptied in alternating cycles. This enables non-stop vacuuming.



Hand regulator

For adjusting the suction power, for example in shallow water.



Wastewater discharge

Simply dispose of it as »organic fertiliser« in a flower bed or the sewer.



Handle, transport rollers + suction tube receptacle

Fast and convenient transport to the pond site via the adjustable and ergonomic handle.



Debris collection bag

Ideal for returning cleaned water when suctioning larger particles > 1 mm (not suitable for pond silt).

TECHNICAL DATA

		PondoVac 4
Dimensions (L x W x H)	mm	435 x 395 x 670
Rated voltage		220–240 V / 50 Hz
Power consumption	W	1700
Power cable length	m	4.00
Net weight	kg	13.10
Guarantee* ^g (+ request guarantee)	Years	2 + 1
Suction depth max.	m	2.40
Length, suction hose	m	5.00
Length discharge hose	m	2.50
		Not available in GB !
Item no.		50388

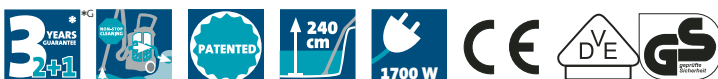

Extras

Top 3 product characteristics

- Continuous vacuum thanks to patented two-chamber system
- Maximum suction depth of 2.4 m
- Also ideal for cleaning pools and swim ponds

Recommendation

High-power suction to a depth of 2 m

Included in the scope of delivery

Universal nozzle

The all-round talent (2–10 mm) reliably removes pond floor debris, without vacuuming up gravel.



Special string algae nozzle

With this nozzle, strands of string algae can be separated and very easily removed.



Area nozzle

With rollers, integrated brush and weight for large areas such as in pools or swim ponds.



Brush nozzle

For corners and stubborn debris.



Wet suction nozzle

Wet suction function for indoors and outdoors



Accessories

Extension discharge set PondoVac

2.5 m hose with connection union and collection bag for coarse debris particles. Not suitable for pond silt!
Item no. 55448





PONDovac 4 (EXCLUSIVELY AVAILABLE IN GB)

Convenient pond and pool vacuuming without bothersome interruptions



- Vacuum non-stop thanks to the patented two-chamber system – simultaneous vacuuming and emptying of the tank
- Maximum suction depth of 2.4 m thanks to high-performance 1700 W motor with optimised blade geometry
- Can be used for cleaning garden ponds, pools and swim ponds as well as a wet vacuum in the household
- Transparent suction tube for flow-through control
- Easy to move with transport rollers and adjustable handle
- Delivered with special string algae nozzle, widened universal nozzle, wet vacuum brush, brush nozzle for corners and stubborn debris, debris collection bag for retention of coarse particles, 5 m suction hose and 2.5 m discharge hose
- Hand regulator for adjusting the suction power

PRODUCT DETAILS



Two-chamber system

Two same-size cylinders are filled and emptied in alternating cycles. This enables non-stop vacuuming.



Hand regulator

For adjusting the suction power, for example in shallow water.



Wastewater discharge

Simply dispose of it as »organic fertiliser« in a flower bed or the sewer.



Handle, transport rollers + suction tube receptacle

Fast and convenient transport to the pond site via the adjustable and ergonomic handle.



Debris collection bag

Ideal for returning cleaned water when suctioning larger particles > 1 mm (not suitable for pond silt).

TECHNICAL DATA

		PondoVac 4
Dimensions (L x W x H)	mm	380 x 415 x 685
Rated voltage		230 V / 50 Hz
Power consumption	W	1700
Power cable length	m	4.00
Net weight	kg	13.06
Guarantee* ^g (+ request guarantee)	Years	2 + 1
Suction depth max.	m	2.40
Length, suction hose	m	5.00
Length discharge hose	m	2.50
		Exclusively available in GB !
Item no. (GB-Version only)		50391

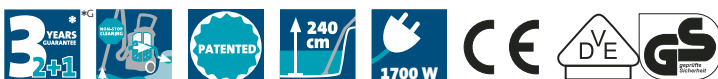

Extras

Top 3 product characteristics

- Vacuum without interruption thanks to patented two-chamber system
- Maximum suction depth of 2.4 m
- Also ideal for cleaning swim ponds

Recommendation

High-power suction to a depth of 2 m

Included in the scope of delivery

Universal nozzle

The all-round talent (2–10 mm) reliably removes pond floor debris, without vacuuming up gravel.



Special string algae nozzle

With this nozzle, strands of string algae can be separated and very easily removed.



Brush nozzle

For corners and stubborn debris.



Wet suction nozzle

Wet suction function for indoors and outdoors



Accessories

Extension discharge set PondoVac

2.5 m hose with connection union and collection bag for coarse debris particles. Not suitable for pond silt!
Item no. 55448





Extras

Recommendation

Regular care is important for healthy growth of pond plants. For this we recommend the new FlexiCut 2 in 1. It simultaneously cuts and firmly grasps so that plant remains can be quickly and easily removed from the pond. The adjustable head protects the pond liner from cuts and enables convenient work, even at locations that are difficult to access.

USEFUL POND HELPERS

For ease of use in and around the garden pond

Nets



		Profi Fish net	Profi Pond net	Fish net Small	Fish net Large	Algae net Small	Algae net Large
Dimensions (L x W x H)	cm	40 x 40 x 40	40 x 30 x 20	25 x 25 x 17	38 x 38 x 26	25 x 17 x 7	38 x 26 x 9
Shape		Trapezoidal	Rectangular	Round		Rectangular	
Mesh width		6 mm	0.5 mm	9 mm		0.3 mm	
Guarantee* ^G	Years	2					
Handle type		Telescopic		Fixed	Telescopic	Fixed	Telescopic
Handle length min.	cm	113					
Handle length, max.	cm	190		113	180	113	180
Product characteristics		<ul style="list-style-type: none"> • Suitable for catching and removing fish • Fine-mesh scoop net reduces the danger of injuring the fish • Easy work thanks to telescopic aluminium handle • Including 1 replacement net 	<ul style="list-style-type: none"> • Suitable for removing fine algae and plant remains • Fine-mesh and robust scoop net for all tasks in and around the garden pond • Easy work thanks to telescopic aluminium handle • Including 1 replacement net 	<ul style="list-style-type: none"> • Suitable for catching and removing fish • Easy handling thanks to aluminium handle 	<ul style="list-style-type: none"> • Suitable for removing fine algae and plant remains • Even small debris particles are effortlessly removed via the extremely fine-mesh net • Easy handling thanks to aluminium handle 		
Item no.		50079	50078	36300	36299	36298	36297

AquaNet pond nets



		AquaNet pond net 1 3 x 4 m	AquaNet pond net 2 4 x 8 m	AquaNet pond net 3 6 x 10 m
Dimensions (L x W)	cm	300 x 400	400 x 800	600 x 1000
Mesh width		20 mm		
Number of ground stakes	Unit	8	12	18
Guarantee* ^G	Years	2		
Product characteristics		<ul style="list-style-type: none"> • Protects the pond from falling leaves in autumn • Prevents silt build up on the pond floor and formation of fermentation gasses due to falling branches and leaves • Fine-mesh, robust, and weather resistant • Incl. ground stakes for fastening 		
Item no.		53751	53752	53753

Pond tools



		FlexiCut 2 in 1	Pond scissors	Pond pliers
Dimensions (L x W x H)	cm	166 x 6 x 4	128 x 10 x 8	126 x 15 x 17
Handle type		Fixed		
Handle length, max.	cm	158	125	
Guarantee* ^G	years	2		
Product characteristics		<ul style="list-style-type: none"> • 2 in 1 pond scissors that simultaneously hold the cut plants when cutting • The head with adjustable work angle protects the pond liner from cuts and enables convenient work • Also suitable for cutting other plants and thin branches • Scissors head available as spare part from OASE (item no. 51272) 	<ul style="list-style-type: none"> • For trimming tasks in and around the garden pond • Trapezoidal blade 52: 53 mm x 19 mm x 0.63 mm (not available from OASE as spare part) 	<ul style="list-style-type: none"> • For removing foreign objects from the pond • Pond cleaning without dirty hands
Item no.		51243	36303	36304



Extras



Top 3 product characteristics

- To -20°C an ice-free area is generated around the float element
- IceFree Thermo 330 contains an integrated frost monitor
- Temperature zones in the pond remain intact

Recommendation

A minimum water depth of 80 cm is recommended for reliable operation of the IceFree 20.

ICEFREE *Ensure your pond is safe this winter*

- To -20°C an ice-free area is generated around the float element
- Ensures oxygen access to the water and allows harmful fermentation gases to escape
- Extremely energy-efficient pump technology without additional heating element for the IceFree 20 (requires a depth of at least 80 cm)
- Maintains the warm temperature zones on the floor, particularly with the IceFree Thermo models
- The IceFree Thermo is also suitable for shallower ponds, as well as for continuing cold periods with freezing temperatures
- IceFree Thermo 330 contains an integrated frost monitor function. It activates the device only when there is danger of frost. This means energy is not consumed on warmer days
- Resistance heating technology for higher performance in the frost area and protection against temperature damage

TECHNICAL DATA



		IceFree 20	NEW IceFree Thermo 200	NEW IceFree Thermo 330
Dimensions (L x W x H)	mm	127 x 85 x 92	300 x 135 x 270	300 x 135 x 334
Rated voltage		230 V / 50 Hz	220–240 V / 50 Hz	
Power consumption	W	5	200	330
Power cable length	m	10.00		
Net weight	kg	1.06	1.15	1.25
Guarantee* ^G	Years	3	2	
Max. flow rate	l/min	7	–	–
Meter water column max.	m	0.75	–	–
Frost monitor function		No		Yes
Item no.		56534	51230	51231





Extras

Recommendation

Ensure that you have a well maintained filter system. It can save you a lot of work. More in this regard starting on page 80.

The comprehensive AquaActiv care program helps you care for your garden pond and your fish. Starting on page 166.

POND CARE – IT'S EASY

Suitable helpers for any season

Spring, summer, autumn and winter: Each season has its peculiarities, and thus the garden pond also requires appropriate care. We have put together several tips for seasonal cleaning and care to ensure enjoyment of your pond throughout the year, to ensure the well-being of the fish and that the natural balance remains intact.

Spring: Getting started! At the start of the season there are some things to do. Now it is time for water cleaning and plant care. Optimal water conditions can be easily achieved with the basic care product AquaActiv OptiPond, and you can really get the filter biology moving with the BioKick filter starters. The algae net removes bothersome pond growth, and to prevent subsequent algae growth simply suction up any silt on the pond floor, ideally with the PondoVac 4. Bring on the summer!

Summer: The motto for this season is: As little as possible and as much as necessary. Only intervene in a support capacity, in order to maintain the beauty of your garden pond for as long as possible and to prevent the body of water from spoiling. Remove undesired leaves and string algae, and cut back plants that have blossomed with the FlexiCut 2 in 1 pond scissors, so that the water quality is not impaired due to excess nutrients from the roots. In this season a surface skimmer not only ensures a good view of your fish, it also ensures better water quality. Ensure the water level is topped up, if the quantity of water is reduced due to evaporation in dry spells. Keep the filter system, as

well as watercourses run 24 hours per day. Your pond in addition will be supplied with important oxygen. And then: Enjoy the most beautiful time of year at your pond!

Autumn: In the Autumn things get serious: Use of effective pond helpers is now required. Remove silt and other sediments (e.g. with the PondoVac 4) and remove the plant remains. Now strengthen the fish for the winter with QuickFit and cover the garden pond with the AquaNet pond net; the net prevents leaves from blowing into the pond, sinking to the bottom, and prevents excessive nutrient input from impairing the water quality.

Winter: Naturally winter is the quietest time of year. This also applies for the pond and its care. Nevertheless, you should prepare the garden pond and its inhabitants for colder temperatures and frost. The fish in the pond need a depth of at least one metre, so that there is sufficient space for settlement and warmer zones in spite of the layer of ice. Always ensure that there is a small hole in the ice cover, so that pond inhabitants can breathe and fermentation gases can escape. A practical ice preventer from the IceFree series (page 164) helps in this regard. Using PhosLess inserts during the winter removes excess phosphates and thus prevents algae growth in the new season. Also remember to make the entire filter system winter-proof in accordance with the recommendations – this ensures that your garden pond and its inhabitants are prepared for the cold season.



AquaActiv: Clear living water

The sensitive pond biology is frequently burdened by excessive fish stock, rainfall and too much sunlight or leaves. The consequences are poor water quality, excessive algae and silt formation or even fish disease.

AquaActiv is an effective treatment against these factors and restores the biological balance in the pond. You help your pond to help itself.

The entire concept of the successful pond care series has been optimised, extended and logically coordinated. Innovative products, developed based on our years of experience, and with support from recognised experts, have been added.

The AquaActiv **3-Step Plan** shows you the biologically effective path to an algae-free

AquaActiv	January	February	March	April	May	June	July	August	September	October	November	December	Page
C	ALGo Universal*				For treatment of acute algae problems								172
	ALGo Direct*				For treatment of acute algae problems								172
	ALGo Bio Protect				Biological prevention of algae problems								172
B	PhosLess algae protection	Withdraws phosphates before algae occur		Preventative measure after algae treatments					Withdraws phosphates before algae occur				171
	PhosLess Direct	Withdraws phosphates before algae occur		Preventative measure after algae treatments					Withdraws phosphates before algae occur				171
	PondLith			Biological filter medium for nutrient decomposition									171
	Carbon			Removes tannic substances and pollutants									171
	AquaHumin			Biological algae protection									171
A	BioKick starter cultures		For starting the pond biology after winter			For a new system, acute problems, changing water without filter cleaning							169
	SediFree	Sediment decomposition after winter				After spring			Sediment decomposition before winter				170
	OxyPlus	For stimulation and vitalisation				Immediate aid for Lack of oxygen				Support in winter			170
	PondClear			For mineral cloudiness as well as suspended particles (not algae)									170
	OptiPond	Throughout the year, primarily after heavy rainfall and before algae treatment, likewise if there is low carbonate hardness and for pH value fluctuations											170
	BioKick Care		For clear, healthy pond water and for promoting the biological balance										170
													Page
	Safe&Care	For refilling, changing water, fish stock, and after use of medication							For preparing the fish for the winter				170
	QuickFit		For strengthening the fish after winter		After recovery from disease or injury				For preparing the fish for the winter				175

* Use algacides safely! Always read the label and product information before use!

pond and allocates the AquaActiv products to steps A, B, or C. In this plan the two first steps ensure decomposition of the excess nutrients, step C contains algacides that you can subsequently use if steps A and B are not successful.



Clear division of the products facilitates the selection. In addition there is extra talent behind the clever bottle concept; the supplemental container has three functions:

1. Measuring cup
2. Storage space for useful accessories that come with the product, such as test strips or instructions for use
3. Storage compartment for 2-component products, such as »BioKick Fresh«.



Tip!

Your direct path to ideal water values:

If you want to know precisely what the status of the water quality is in your pond, with the new OASE online laboratory you get the analysis of individual parameters, and best of all – you also get helpful tips and recommendations:

www.oase-livingwater.com/onlinelabor





Tip!

Your direct path to ideal water values:

www.oase-livingwater.com/onlinelabor



WATER ANALYSIS

For safe monitoring of water values

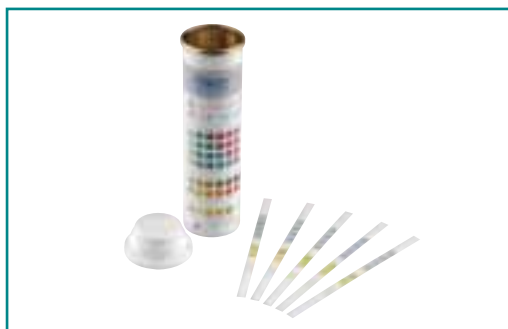

AquaActiv	QuickStick 6 in 1	Water analysis Pro set
Description	<ul style="list-style-type: none"> • For fast, simple, and reliable water analysis of the 6 most important values • One minute is all it takes • Suitable for testing approximately 50 water samples (300 parameters) 	<ul style="list-style-type: none"> • Professional drop solutions for precise determinations of all important pond parameters • Phosphate test incl. shelf life check solution • Incl. measurement accessories, colour charts, and useful application instructions • Delivered in a modern plastic case
Simple and accurate determination of:		
pH value	•	•
Total hardness (GH)	•	•
Carbonate hardness (CH)	•	•
Nitrite (NO ₂)	•	•
Nitrate (NO ₃)	•	•
Phosphate (PO ₄)	–	•
Ammonium (NH ₄)	–	•
Ammonia (NH ₃)	–	•
Chlorine (CL ₂)	•	–
Item no.	50570	50571

Extras

Activation »BioKick fresh«

1. For activation add the preserved dry cultures to the nutrient solution.
2. The solution turns yellow and indicates the correct mixture.
3. After 20 minutes the microorganisms are active and can be added in the filter or pond.

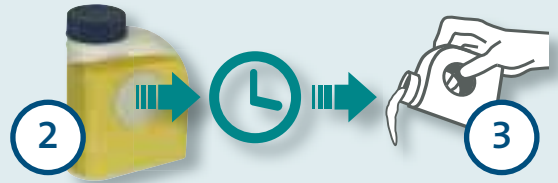

STARTER CULTURES

For use in filter and pond



AquaActiv	BioKick CWS			BioKick fresh	BioKick Premium
	Starter bacteria				High-performance bacteria for pond filters
Container size	100 ml	200 ml	2 l	500 ml	4 x 20 ml
Suitable for ponds up to max. m ³	5.0	10.0	100.0	10.0	40.0
Description	<ul style="list-style-type: none"> Wakes up the biology in the filter in the spring or for a new start Detoxification of nitrite, ammonium, and ammonia starts immediately Well-suited for post-dosing if some of the water is changed or when cleaning the filter Follow-up dose is not required Easy application Free of pathogens More than 10 million active microorganisms/ml* Ideal for near natural garden ponds Full capacity of the pond filter within a few weeks 			<ul style="list-style-type: none"> Like BioKick CWS, however: Combination of dry culture and nutrient solution Contents: 450 ml nutrient solution + 50 ml bacteria concentrate Long lasting and highly active Now ready to start after 20 minutes through significantly increased number of bacteria Ideal for activating filter systems, particularly if there is fishstock More than 1.000 million active microorganisms/ml* Ideal for ponds with moderate fish stock Decomposition capacities in the filter within 2 weeks 	
Optimal supplements	OptiPond, Safe&Care			OptiPond, Safe&Care	OptiPond, Safe&Care
Item no.	51277	50295	50939	50562	51280

* At the time of filling

IMPROVING WATER QUALITY



AquaActiv 		 OptiPond For the best water conditions		 Safe&Care De-chlorinator with mucous membrane protection		 OxyPlus Immediate oxygenation with fast sinking granules	
Container size		500 ml	5 l	500 ml		500 ml	
Suitable for ponds up to max.	m ³	5.0	50.0	10.0		10.0	
Description		<ul style="list-style-type: none"> Treats soft well water or rain water Increases the carbonate hardness in exhausted water Stabilises the most important parameters Binds ammonium & ammonia Prevents dangerous drops in acidity Contains vital minerals and trace elements Ideal after heavy rainfall Product is marked »irritant«! 		<ul style="list-style-type: none"> Makes tap water suitable for fish, plants and wildlife Immediately binds chlorine and toxic heavy metals Bio-protection colloids protect the mucous membrane from injury and infection Ideal after the use of medication 		<ul style="list-style-type: none"> Increases the oxygen content in the pond Prevents formation of hazardous fermentation gas Supports the biological self-cleaning properties of the water Ideal for lack of oxygen e.g. if there is heavy algal bloom Product is marked »irritant«! 	
Optimal supplements			Safe&Care		OptiPond		–
Item no.		50557	50558	50563		50559	

IMPROVING WATER QUALITY



AquaActiv 		 PondClear For crystal clear pond water			 SediFree Pond silt remover		 BioKick Care Biological pond care	
Container size		250 ml	500 ml	5 l	500 ml	5 l	250 ml	2 l
Suitable for ponds up to max.	m ³	5.0	10.0	100.0	10.0	100.0	10.0	100.0
Description		<ul style="list-style-type: none"> Binds mineral substances that cause cloudiness Binds organic substances from fish waste or leaves that cause cloudiness Effective against fine, non-filterable pollutants such as phosphates and heavy metal combinations Accumulated flocculated material can be easily skimmed off with a net Not suitable for algae control 			<ul style="list-style-type: none"> Transformation of organic silt via special high-performance bacteria Gentle cleaning without refilling the pond or dredging, etc. Focused prevention of silt, long-term turbidity and algal bloom Granulate with active oxygen sinks into the silt and oxidises it Subsequent rapid decomposition of the silt through special bacteria Product is marked »irritant«! 		<ul style="list-style-type: none"> Activates the pond water with particularly important bacteria strains Promotes the biological balance in the pond Supports the decomposition of nutrients, such as ammonium, nitrite or nitrate Provides clear, healthy pond water and ensures good viewing depths Removes deposits of dead organic material, such as silt or fish waste Contains autotrophic and heterotrophic cultures, as well as lactic acid bacteria (more than 1.000 million bacteria/ml)* Natural raw materials, consequently 100 % compatible for animals and plants Reduces the cleaning of filter systems Contains natural minerals and promotes the brilliant colours of the koi 	
Optimal supplements		OptiPond			OxyPlus, PhosLess		OptiPond	
Item no.		51276	50552	50555	50560	50561	51283	51288

NEW

BINDING NUTRIENTS

AquaActiv		 NEW PhosLess Direct Algae protection with immediate effect		 PhosLess Algae protection		 PhosLess Algae protection refill pack	
Container size		500 ml	5 l	2 l filter media tubes		2 bags 1 l	
Suitable for ponds up to max.	m ³	10.0	100	40.0		40.0	
Suitable for ponds with fish stock	m ³	10.0	100	10.0		10.0	
Description		<ul style="list-style-type: none"> • Binds excess phosphates and reduces algae growth • Binds hydrogen sulphides that can cause bad odours • Simple application directly onto the pond surface • Keeps phosphates in anaerobic zones, such as pond silt • 500 ml binds up to 20 g of phosphates 		<ul style="list-style-type: none"> • Binds excess phosphates and reduces algae growth • Effective through 2-component technology in the exchange system • Binds harmful heavy metals like copper, lead or zinc • Can be used in the Biotec 18/36 filters, as well as in moving water • Dimensions per filter media tube 310 x 86 mm 		<ul style="list-style-type: none"> • 15 x 2 bags, each with 1 litre PhosLess CA and PhosLess FS • Suitable for use in larger bodies of water • Replacement medium for PhosLess filter media tubes • Can also be directly applied in moving water • Ideal in ProfiClear Premium 	
Item no.		51284	51287	36981		57477	

BINDING NUTRIENTS

AquaActiv		 PondLith Natural ammonia removal		 AquaHumin Biological algae protection		 Carbon 2 l Natural pollutant removal	
Container size		2.5 kg		10 l		2 bags 1 l	
Suitable for ponds up to max.	m ³	2.5		10.0		10.0	
Suitable for ponds with fish stock	m ³	1.30		10.0		10.0	
Description		<ul style="list-style-type: none"> • Zeolite-based natural product • High performance filter material • For removal of ammonium and ammonia and consequent reduction of nitrite and nitrate • Grain size 5–10 mm • Withdraws the nutrient base for green algae • Effective for approximately 125 days and can be recharged • Per m³ pond volume 1 kg (without fish stock), 2 kg (with fish stock) or 3 kg (for koi ponds) 		<ul style="list-style-type: none"> • Special peat for the garden pond • Free from chemical additives, nematodes, pathogens and substances that are toxic to plants • 30–45 % humic acid • Softens the water and reduces the pH value • Restores the biological balance • Prevents excessive algae growth • Delivered in full colour packaging 		<ul style="list-style-type: none"> • Removes medication and other chemical residue (to 10 m³) • Helps in the case of yellow or brown colouration (to 5 m³) • Absorbs organic pollutants and ozone • High-quality charcoal with extremely large surface area 950 m²/g • pH neutral • No phosphate increase of the pond water • Robust, low-dust pellets (3 mm) • Incl. 2 x 1 l dosing bag 	
Item no.		54049		53759		50938	



Recommendation

Many AquaActiv products are also available in attractive large containers.



CONTROLLING ALGAE

AquaActiv	 AlGo Universal Algae control			 AlGo Direct String algae control			 AlGo Bio Protect Biological algae protection	
	Container size	250 ml	500 ml	5 l	250 ml	500 ml	5 l	500 ml
Suitable for ponds up to max.	m ³	5.0	10.0	100.0	5.0	10.0	100.0	10.0
Description	<ul style="list-style-type: none"> Effective against the most frequently occurring algae types, string algae, suspended algae, and slime algae Inhibits photosynthesis of the algae; algae starves Effective without controversial copper additives Harmless for plants and animals when used properly Specifically effective against duckweed Prevents further algae growth <p>• Use algaecides safely! • Always read the label and product information before use!</p>			<ul style="list-style-type: none"> Especially for localised and fast treatment of string algae, e.g. in watercourses Works through direct contact Microorganisms decompose dead algae Includes pH-/KH quicktest Active ingredient breaks down algae into O₂ and H₂O within a short time, safe use in swim ponds is possible Effective without controversial copper additives Product is marked »harmful to health«! <p>• Use algaecides safely! • Always read the label and product information before use!</p>			<ul style="list-style-type: none"> Physically inhibits algae growth due to sunblock effect Contains a humic acid complex of natural raw materials Free of heavy metals and biocides Generates a barely perceptible amber colour, the vital UV light supply for the algae is significantly reduced Protects against excessive algae growth 	
Optimal supplements	OptiPond, PhosLess			OptiPond, PhosLess			OptiPond, PhosLess	
Item no. (GB-Version: String Algae Control)	51274	50543	Not available in GB!	Not available in GB!				
Item no.	51265	50542	50545	51275	50546	50549	51279	

Extras

New in the product range:
Category D – Disinfection



In many gardens, water has become a regular trend in many peoples design. The categories extend from small ornamental fountains to large architectural pools. However the typical formation of bio-film, build up of odours, micro-organisms or algae growth on surfaces quickly develops and for most garden owners, becomes an irritation; certainly for modern garden design in particular, clear pools are the main focus. The Category D products ensure a body of water that is as sterile as possible – note, however, that disinfection that occurs is prohibited for use in fish ponds or wildlife ponds. Correctly dosed they keep all other bodies of water, such as swim ponds, architectural ponds or ornamental fountains sustainably clear and fresh.



Disinfection

AquaActiv	 NEW AlGo Fountain Ornamental fountain clarifier	 NEW OxyPool 9.9 % Cleaner for larger ponds and swim ponds
Container size	500 ml	25 l
Suitable for ponds up to max. m ³	0.2	100
Description	<ul style="list-style-type: none"> • Fast help against algae and odours in ornamental fountains, decorative pools and water features • Keeps the water fresh and clear • Also effective against slimy bio-film formation • Prevents calcium deposits • Compatible with surfaces and technology • Protects against bacteria and fungus • Long-lasting effect • Not suitable for ponds with animals or plants <ul style="list-style-type: none"> • Use biocides safely! • Always read the label and product information before use! 	<ul style="list-style-type: none"> • Efficient water cleaner with the active ingredient hydrogen peroxide 9.9 % and silver ions • Eliminates algae and acts against bacteria and fungus • Suitable for ornamental ponds, swim ponds, spray fountains and water features • Leaves, silt, algae and calcium deposits are floated to the surface and can be removed • Up to 100 % biologically degradable, without chlorine and alcohol additives • Colourless and odourless • Product is marked »harmful to health«! <ul style="list-style-type: none"> • Use biocides safely! • Always read the label and product information before use!
Item no.	Not available in GB	Not available in GB
Item no.	51278	51062

Fish medicine*: For healthy fish.

With the OASE fish medicine you support the recovery of your pond inhabitants if there is disease or new stock in the water. Competent, reliable and highly-effective; the products ensure the health and well-being of your fish. We have developed these special products in close collaboration with the company,

Aquarium Münster, esteemed for more than 80 years of experience in the keeping and medical treatment of ornamental fish. Diseases such as parasite infestations, fungal or worm infestations or sometimes mixed infections can be treated with these products.



**Aquarium
Münster**

Fish like us

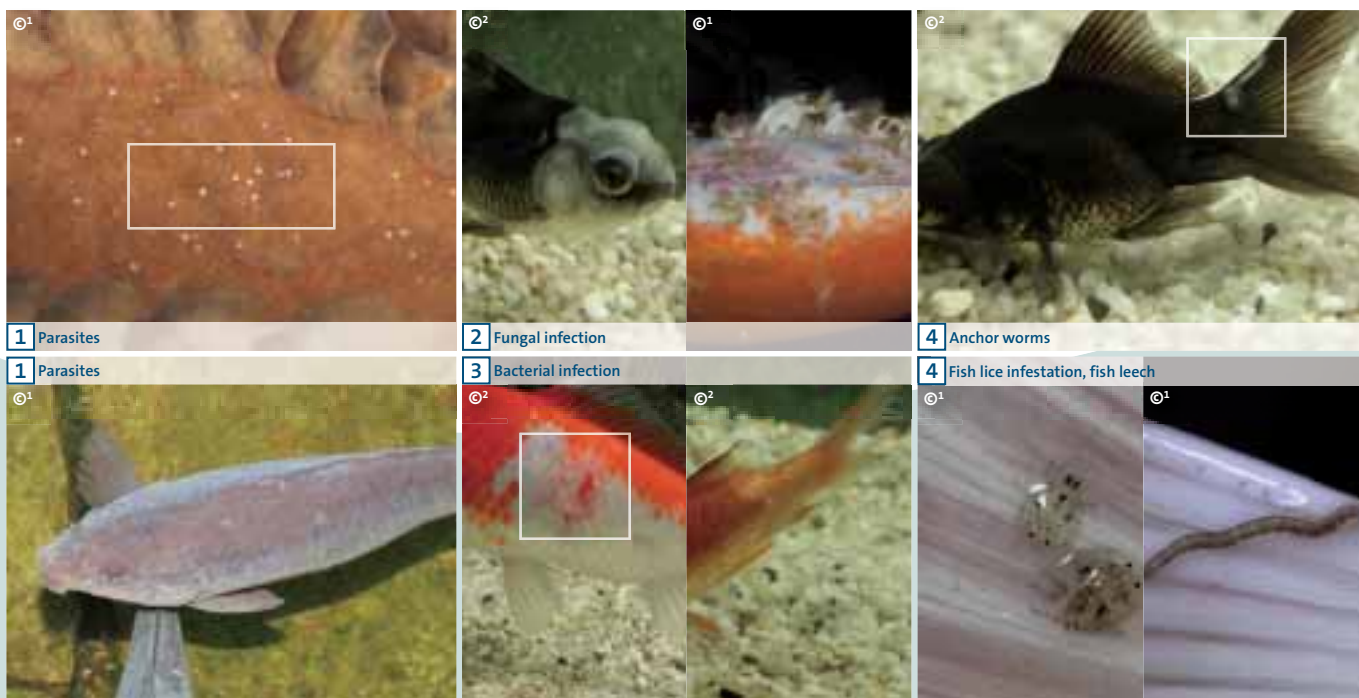

Fish medicine	Universal ** Against the most frequent diseases of pond fish		1 AntiParasite ** Against single-cell parasites		2 AntiFungus ** Against fungal infections		3 AntiBacteria ** Against internal and external bacterial infections	
Container size	500 ml	5 l	500 ml	5 l	500 ml	5 l	500 ml	5 l
Suitable for ponds up to max. m ³	10.0	100.0	10.0	100.0	10.0	100.0	10.0	100.0
Area of application	<ul style="list-style-type: none"> Unclear diagnosis Mixed infections For prevention of disease Bacterial infections Single-cell parasites (protozoa) Fungal diseases 		Single-cell parasites (protozoa) such as <ul style="list-style-type: none"> Skin parasites (Costia, Trichodina, Chilodonella), White-spot disease (Ichthyophthirius) Velvet (Piscinodinium) Cryptobia Bacterial diseases that accompany these infections 		<ul style="list-style-type: none"> Fungal diseases (Dermocystidium and Saprolegnia) Bacterial diseases that accompany these infections Note: Fungal infections usually occur where the skin has been injured		Internal and external bacterial infections, such as <ul style="list-style-type: none"> Ascites (Aeromonas, Pseudomonas) Mouth rot (Columnaris) Fin rot (Myxo bacteria) Hole syndrome (Aeromonas, Pseudomonas) Streptococci Injuries, inflamed skin 	
Symptoms	<ul style="list-style-type: none"> Whitish-yellow, slime coverings Coverings that resemble cotton wool Ulcers, wounds, inflammations Flicking Loss of skin & scales Blood spots 		<ul style="list-style-type: none"> White-grey to dark velvet-like coverings White spots Projecting gills Increased respiratory activity Scraping against objects Clamped fins Lethargy and emaciation 		<ul style="list-style-type: none"> Velvet like covering on gills, body and fins Whitish brownish covering on wounds 		<ul style="list-style-type: none"> Loss of skin & scales Swelling, reddening Broken skin, open wounds, ulcers Fin rot, raised scales Slowed or accelerated movements Flicking General darkening Protruding bellies 	
Optimal supplements	QuickFit		QuickFit		QuickFit		QuickFit	
Item no.	50564	50927	50565	50928	50566	50929	50568	50931

Fish medicine	4 AntiWorm ** Active ingredient: Diflubenzuron Against fish lice, as well as skin worms, gill worms, and tapeworms		QuickFit Makes fish fit faster		Safe&Care De-chlorinator with mucous membrane protection	
Container size	500 ml	5 l	500 ml	5 l	500 ml	
Suitable for ponds up to max. m ³	10.0	100.0	10.0	100.0	10.0	
Area of application	Multi-cellular parasites (metazoa) such as <ul style="list-style-type: none"> Fish lice (Argulus) Anchor worms (Lernaea) Skin worms (Gyrodactylus) Gill worms (Dactylogyrus) Tapeworms (Cestoden) 		<ul style="list-style-type: none"> With valuable aloe vera extract, trace elements and vitamin C Strengthens the immune system and reduces susceptibility to disease Has an infection-inhibiting effect and rests gently on the skin like a bandage Reduces stress and enhances well-being 		<ul style="list-style-type: none"> Makes tap water suitable for fish, plants and wildlife Immediately binds chlorine and toxic heavy metals Bio-protection colloids protect the mucous membrane from injury and infection Ideal after the use of medication 	
Symptoms	<ul style="list-style-type: none"> Increased respiratory activity Emaciation in spite of normal feeding behaviour Heavy abrasion Fish lice, anchor worm, fish leech (visible with the naked eye) 		<ul style="list-style-type: none"> Ideal for new stock, transport, after recovery from disease or injury, and for injuries 			
Optimal supplements	QuickFit		OptiPond		OptiPond	
Item no.	50567	50936	50569	50937	50563	

* GMP quality standards (Good Manufacturing Practice – guarantees constant physical, chemical and microbiological inspections, from receipt of raw material to manufacturing of the product).
 ** The products, Universal, AntiParasite, AntiFungus, AntiBacteria and AntiWorm are freely available medications in accordance with § 60 of the German Drug Act (AMG).

ILLUMINATION & POWER

Pond illumination

- 178 Advisor – pond illumination

Halogen spotlights

- 180 LunAqua Micro Set
- 180 LunAqua 2/12 V
- 180 LunAqua 3 Solo
- 181 LunAqua 3 Sets
- 181 Profilux E 100
- 182 LunAqua 10 system

LED spotlights

- 184 LED systems
- 185 LunAqua Terra LED
- 186 Waterfall Illumination
- 188 LunaLed
- 189 LunAqua Classic LED
- 190 LunAqua Mini LED
- 191 LunAqua Maxi LED

Power management & Solar

- 192 Advisor – power management & solar components
- 194 InScenio
- 196 Solar components



ILLUMINATION & POWER: FASCINATING LIGHT AND ENERGY EFFICIENCY COMBINED

Every garden owner looks forward to the quiet evening hours as they enjoy relaxing outside alone or with friends. The flexible, economical lighting sets from OASE provide atmosphere.

Bring the late hours to life with a variety of possibilities from OASE. With well placed

flood lights or spotlights, such as the OASE LunAqua series, trees and shrubbery can be highlighted and the water world can be made luminous. For example, the LunAqua Terra LED light can be fitted flush to the ground; there is no tripping hazard. Thanks to its small dimensions, modern



*»My pond becomes
a luminous haven
of tranquillity«*

**Easy installation
as a complete set!**

LED technology offers flexible design and setup possibilities on terraces, paths, in and around the pond, as well as high energy efficiency and safe 12 V technology. Flexible InScenio power management ensures reliable power supply, both for illumination and for the entire pond technology.

Operating the technology via remote control is comfortable and convenient. And where mains power is not available OASE has suitable products for your haven of tranquillity with its solar product line.

Pond illumination: Radiantly beautiful

When the colours of trees and plants fade into the background in the evening, it is light that can enchant. OASE provides garden owners with a variety of possibilities to lend the residential garden a special charm. Special effects are produced when shrubs or grasses obstruct the light beam and ensure exciting shadows. Skilfully illuminated,

figures and ornaments ensure a mystic atmosphere. Bubbling stone fountains, for example, can be easily transformed into highlights through the LED illumination of the LunaLed S series. Even watercourses are radiant with a new light, with the aid of our LunAqua Maxi LEDs.





The **LUNAQUA TERRA LED** that is recessed into the ground for illuminated paths, driveways or gardens ensures warm and pleasant light.

POND ILLUMINATION

WATER AND LIGHT SKILFULLY COMBINED

WATERFALL ILLUMINATION 30, 60 AND 90 The new waterfall lighting with elegant warm-white LED light provides light accents in our waterfall range. Thanks to the inconspicuous silver-grey plastic holders, the OASE waterfalls in widths 30, 60, and 90 cm, as well as the two standing Waterfall Set 30 and Waterfall Set 60, can be easily retrofitted with light.



ABOVE WATER AND UNDERWATER

LUNAQUA CLASSIC LED The all-rounder among garden lights: Robust and equipped with a 1 W multiple LED in warm-white, the LunAqua Classic LED ensures flexible implementation in and on the pond with a broad beam angle. The light can be quickly and easily aligned thanks to adjustable base. In a star circuit, each light with a 5 m rubber cable, can be easily integrated in every garden scene – all in all an optimal price/performance ratio!



HIGH-QUALITY SET

LUNAQUA MINI LED LED light fixtures that can be ideally integrated in any garden scene. The spotlights can be moved to get the best possible position. They are available in the colour tones of cold white and warm white. Placed in series, each with 1.5 m cable, they are the eye-catchers in every garden – not least thanks to the high-quality stainless steel trim.



STAINLESS STEEL DESIGN

LUNAQUA MAXI LED Appealing design and maximum functionality: With the LunAqua Maxi LED there is nothing more to be desired in a light. The warm-white power LED with interchangeable lens offers multifunctional implementation as pond light fixture, wall light fixture or as an in-ground light fixture, e.g. in a gravel bed. One spotlight per set can be retrofitted. – for maximum flexibility.



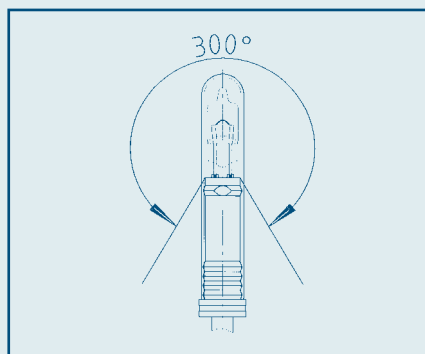

LunAqua Micro Set

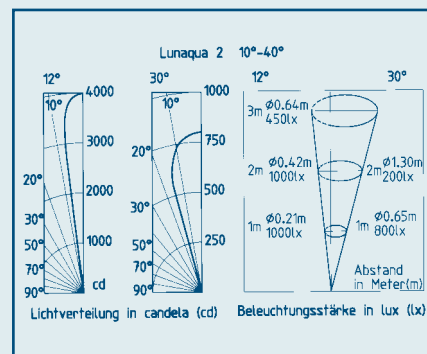

LunAqua 2 / 12 V

LUNAQUA MICRO / 2 / 3 SOLO

TECHNICAL DATA

				
		LunAqua LunAqua Micro Set	LunAqua 2 / 12 V	LunAqua 3 Solo
Dimensions (L x W x H)	mm	64 x 12 x 12	74 x 74 x 92	85 x 85 x 210
Rated voltage	V		12	
Power consumption, light fixture	W	5	20	
Power consumption, set	W	7	–	
Light flux	lm	–	300	
Protection class			IP 68	
Power cable length	m	1.50	3.00	–
Net weight	kg	0.54	0.62	0.44
Guarantee* ^G	Years		2	
Illuminant type			Halogen	
Half peak angle	Degrees	300	10 – 40	
Number of cable entries	Unit	–	1	2
Entry cable size		–	PG 11	
Product characteristics		<ul style="list-style-type: none"> • Small compact indoor fountain light • A hole diameter of just 13 mm is required in bubbling stones • Included in the set: Cable and transformer 	<ul style="list-style-type: none"> • Garden light for use underwater and above the water • For connecting to the UST 150 underwater transformer (see page 183) • Custom light effects thanks to the adjustable beam angle • With ground stake and adjustable mounting base 	<ul style="list-style-type: none"> • Garden light for use underwater and above the water in a new design • Can be connected in series or parallel • 2 cable outlets • High-quality PG couplings • Includes mounting element with adjusting unit and ground stake • With 20 W bulbs • Other 35 W bulbs can be used
		Not available in GB !		
Item no.		50593	54993	57141



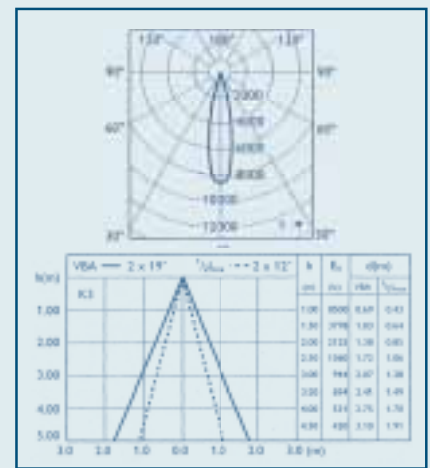

ProfiLux

LUNAQUA 3 SETS / PROFILUX

TECHNICAL DATA

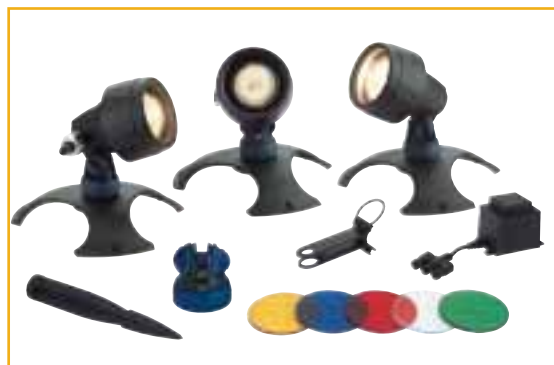

	LunAqua 3 Set 1	LunAqua 3 Set 2	LunAqua 3 Set 3	ProfiLux E 100
Dimensions (Ø x H)	85 x 110			160 x 135
Rated voltage	230 V / 50 Hz			230 V / 50 Hz
Power consumption, light fixture	20			100
Power consumption, set	25	45	68	110
Light flux	300			-
Protection class	IP 68			IP 68
Power cable length	-			7.50
Cable length 12 V device	2.00 (power unit) + 5.00			-
Net weight	1.82	3.08	4.44	4.64
Guarantee*G	2			3
Illuminant type	Halogen			Halogen
Half peak angle	10 – 40			24
Number of cable entries	1			1
Transformer	Yes			Yes
Safety transformer	20 UNITS	45 UNITS	60 UNITS	
Product characteristics	<ul style="list-style-type: none"> • Attractive complete sets offer numerous possibilities for effective garden and pond lighting • Consisting of LunAqua 3 spotlight(s) and with either 1 x, 2 x or 3 x ground stake, wall / floor bracket, spotlight base, nozzle bracket, coloured lens set • Modern design makes the light fixture itself an attractive eye-catcher • With spray water resistant transformer • Spotlights work in a parallel circuit, thus spotlight replacement is easily executed 			<ul style="list-style-type: none"> • Illuminant: 100 watt halogen • High-quality stainless steel spotlight • Stainless steel bracket for simple and safe installation • With quick coupling and 105 VA weatherproof transformer • Only suitable for underwater operation!
Item no. (GB-Version)	57204	57205	57206	-
Item no.	56903	56904	56905	56898





Schematic diagram: Halogen spotlights / LED spotlight systems in use



LUNAQUA 10 SYSTEM

Powerful & flexible: The spotlight system for every implementation site

LunAqua 10 Halogen



LunAqua 10 LED/01



- Optimally matched lighting system
- Robust connection technology with many implementation possibilities
- Seamlessly compatible with the existing LunAqua 10 connection technology
- Easy installation via a connecting cable with convenient special connections

LunAqua 10 Halogen

- Available as spotlight without bulbs, cable and transformer (available as an accessory)
- Pivot range approximately 180° thanks to the integrated mounting bracket

LunAqua 10 LED/01

- Thermal protection function: Luminous intensity is reduced automatically if the ambient temperature is too high
- Incl. illuminant (not dimmable)
- Additional illuminant available as a spare part, easy replacement
- Illumination range to 12 m

Underwater transformer UST 150/01

- Connection possibility for up to 4 spotlights: 4 x 35 W, 3 x 50 W, 2 x 75 W halogen or 4 x 10 W LED spotlight
- With the PowerBox 12 V, up to 12 LunAqua 10 LED/01 spotlights can be connected (8 spotlights in series on one plug-in position)



LunAqua 10 spotlight

This spotlight offers versatile implementation, whether as illumination for floating fountains or as a flexible light system for every garden.



Underwater transformer

Simple and safe – this connection technology is unrivalled.

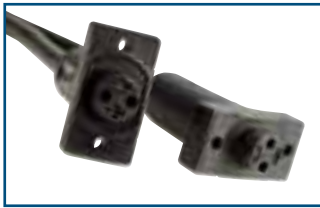

Connecting cable

This robust rubber cable is available in three lengths. Longer connecting cables with larger cable cross-sections are in our commercial catalogue.



LunAqua 35 Set

Halogen spotlight including 35 W bulb, transformer and 7.5 m cable.

Extras

Top 3 product characteristics

- Powerful light system
- Spotlight and transformer suitable for underwater setup
- Flexible extension

Recommendation

With the OASE PowerBox 12 V up to 12 LunAqua 10 LED spotlights can be connected on one UST 150/01 (up to 8 units in one series).

Accessories

Halogen illuminant

35 W Item no. 54035 (Page 214)

50 W Item no. 54036 (Page 214)

75 W Item no. 54037 (Page 214)



PowerBox 12 V AC /01

With the PowerBox up to 12 LunAqua 10 LED spotlights can be connected on one UST 150/01 (up to 8 units in one series).

Dimensions: 75 x 80 x 95 mm

Rated voltage: 12 V

Number of outputs: 2

Item no. 50492 (Page 184)



TECHNICAL DATA

		LunAqua 10 Halogen	LunAqua 10 LED/1	Underwater transformer UST 150/01	Connecting cable 2.5 m/01	Connecting cable 5.0 m/01	Connecting cable 7.5 m/01	LunAqua 35 Set
Dimensions (L x W x H)	mm	145 x 160 x 182		153 x 130 x 89	–	–	–	145 x 160 x 182
Rated voltage	V	12		–	–	–	–	–
Rated voltage (primary, secondary)		–	–	230 V/50 Hz, 12 V	–	–	–	230 V/50 Hz, 12 V
Power consumption	W	35–75	10	150	–	–	–	35
Power consumption, set	W	–	–	–	–	–	–	40
Light flux	lm	1250	365	–	–	–	–	–
Protection class		IP 68						
Power cable length	m	–	–	10.00	2.50	5.00	7.50	9.50
Net weight	kg	0.82	1.20	4.46	0.32	0.56	1.16	2.52
Guarantee* ^{CG}	Years	2						
Illuminant type		Halogen	LED	–	–	–	–	Halogen
Half peak angle	Degrees	24	18	–	–	–	–	24
Cable cross section	mm ²	–	–	–	1.50		2.50	1.50
Item no.		54034	50366	50401	50402	50403	50404	54314



* With 50 W illuminant

Series circuit:

- max. 8 x LunAqua 10 LED / ProfiLux LED in series
- For a series circuit the PowerBox plus cable is additionally required per spotlight!

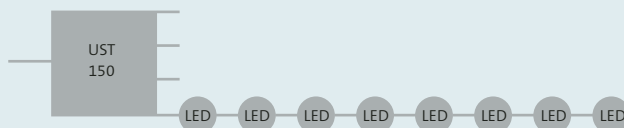
**Star circuit:**

- max. 12 x LunAqua 10 LED / ProfiLux LED

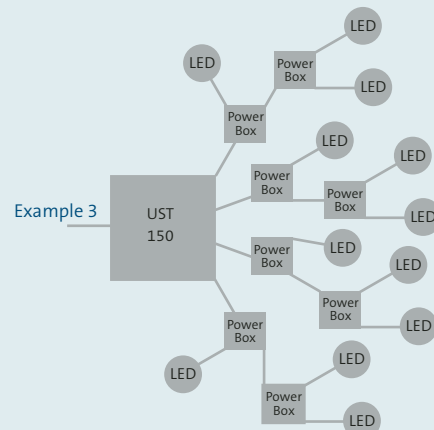
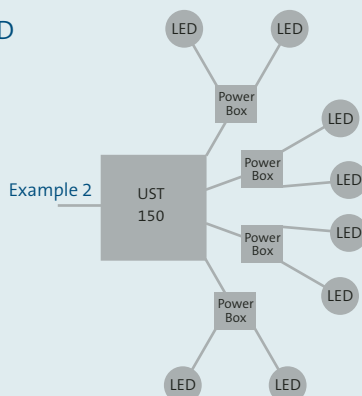
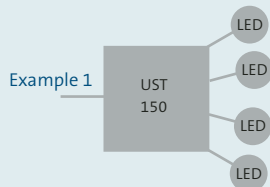

System diagram: Combination possibilities of the LunAqua 10 system

LED SYSTEMS FROM OASE

The world's first IP 68 underwater connection technology with 2 year guarantee^G*

At last, no more unsafe wiring and connecting of light fixtures: The IP 68 connection technology from OASE sustainably ensures safety and it is particularly easy to install.

With the worldwide unique IP 68 connection technology, connection and operation of light fixtures underwater is now particularly safe.

All connecting cables, transformers and power units of this series guarantee all-round water-tightness to a depth of 4 m! An axial flat seal with integrated capillary barrier in the plug connectors of the connecting cable and the associated boxes (PowerBox and DMX box) make it possible. OASE even provides a guarantee*^G of 2 years.

Through this innovative technology the entire system is perfectly matched and can be put together to suit individual requirements:

Simply select from among the extensive OASE assortment of pumps, LED illumination, Jumping Jets, as well as connecting cables and PowerBoxes.

Tips & tricks:

- Our LunAqua 10 LED or ProfiLux LED offer power savings of up to 80 % compared with the halogen variants.
- If the LED illuminant should actually fail, it can be easily replaced by plug connection.
- The cable cross section of the connecting cable that must be used is 2.5 mm² and the maximum cable length should not exceed 60 m for each line overall.

Extras

PowerBox 12 V

With the PowerBox up to 12 LunAqua 10 LED spotlights can be connected on one UST 150/01 (up to 8 units in one series).

Dimensions: 75 x 80 x 95

Rated voltage: 12 V

Number of outlets: 2

Item no. 50492



Extras

Top 3 product characteristics

- Pleasant warm light out of the ground for perfect evening atmosphere
- Individual installation possibilities:
In the garden above the water and underwater
- Easy installation

Recommendation

Whether on the terrace, in the swim pond or in the pavement – the LunAqua Terra LED is suitable for various implementation areas in the garden or in driveways. Installation is incredibly easy: Cable ducts, insert the bulb in the 40 mm bore – the romantic evening atmosphere is provided!

Application examples: The right choice underwater and above the water: LunAqua Terra LED

LUNAQUA TERRA LED

Warm light recessed in the ground –
as complete install set

- Warm white LED light fixture, extremely energy efficient and long lasting
- Crafted in polished, high-quality stainless steel material
- Installation is particularly easy thanks to stainless steel clip for fastening in the 40 mm bore opening
- Robust PUR rubber cables
- IP 68 for continuous safe operation underwater and above the water (IP44 connection)
- Load bearing capacity for pedestrian and vehicular traffic up to 3 t
- 10 m extension cable available as an accessory and suitable for bulb and 6x connector (max. 2 x per strand)

TECHNICAL DATA

		LunAqua Terra LED Set 6	LunAqua Terra LED Set 3	LunAqua Terra LED Solo	LunAqua Terra LED extension cable
Dimensions (Ø x H)	mm	45 x 10			–
Rated voltage	V	12			–
Power consumption, light fixture	W	0.25			–
Power consumption, set	W	4		–	–
Cable cross section (Ø)	mm ²	–			0.25
Light flux	lm	14			–
Protection class		IP 68, IP 44			IP 44
Power cable length	m	10.00	5.00	10.00	10.00
Net weight	kg	1.80	1.20	0.30	0.10
Guarantee*G	Years	2			2
Illuminant type		LED			–
Light colour		Warm-white			–
Half peak angle		Diffuse			–
Stockist PU	Unit	1			–
		Not available in GB !			–
Item no.		50729	51043	51056	51057





The waterfall illumination emphasises the contours of the water pattern and ensures atmospheric lighting



WATERFALL ILLUMINATION

*LED waterfall lighting –
for stylish light accents in the evening*

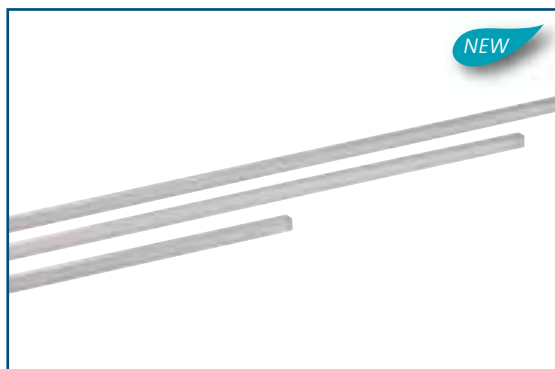

- LED for waterfalls, for terrace pond edge decoration, in widths 30, 60 and 90 cm
- Easy to retrofit thanks to innovative plastic carriage
- Pleasant warm-white light colour
- High-quality, stainless steel enclosure
- Incl. robust 10 m rubber cable and cord transformer

Available from March 2013

PRODUCT DETAILS

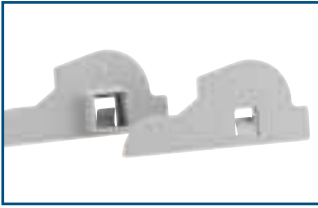

Plastic carriage

The innovative plastic carriage in discrete grey enables easy retrofit of the waterfall lighting at any time.

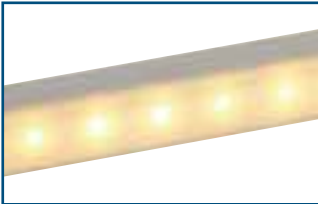

LED

The warm-white, slim line LEDs ensure pleasant lighting.



Attractive water pattern

The light rail is placed at an optimal height in the waterfall and supports a harmonious water pattern.

Extras

Top 3 product characteristics

- Easy to retrofit waterfall lighting
- Pleasant warm-white light colour
- It is also ideal as terrace or pond edge lighting

Recommendation

Combine Waterfall Illumination with Waterfall 30, 60 and 90 (see page 16) or with the stands, Waterfall Set 30 or Waterfall Set 60 Solo (see page 17).

Waterfall 30, 60 and 90



Waterfall Set 30



Waterfall Set 60 Solo



Set focussed accents at the edge of the pond or on the terrace, as well as between cobblestones, or for framing a wooden terrace.

TECHNICAL DATA

These products are on page 18

		NEW	NEW	NEW
		Waterfall Illumination 30	Waterfall Illumination 60	Waterfall Illumination 90
Dimensions (L x W x H)	mm	300 x 13 x 13	600 x 13 x 13	900 x 13 x 13
Rated voltage	V	12		
Power consumption	W	2	4	6
Protection class		IP 68, IP 44		
Power cable length	m	10.00		
Net weight	kg	0.50	1.00	2.50
Guarantee*G	Years	2		
Illuminant type		LED		
Light flux	lm	40	80	120
Light colour		Warm-white		
Item no.		51205	51209	51214





Extras



Application examples: LunaLed 6 s / 9 s

Top 3 product characteristics

- High-quality stainless steel cap
- Easy installation through hose connectors, ideal for bubbling stones
- Adjustable fountain height

Recommendation

Be creative – combine multiple LunaLeds using the OASE multiple distributor (page 212) and design your individual fountain.

LUNALED

Innovative illumination with modern LED technology

- Each has 6 or 9 neutral-white LEDs
- Suitable for use underwater and above the water
- Suitable for permanent underwater use (protection class IP 68)
- High-quality stainless steel cap, with which the water flow rate can be regulated
- Diameter 30 mm or 50 mm
- Half peak angle of the LED: 30°
- Incl. low-volt plug transformer
- Easy installation via the innovative hose connector

LunaLed 6 s / 9 s



LunaLed 6 s / 9 s hose connectors



TECHNICAL DATA

These products are on page 22.

		LunaLed 6 s	LunaLed 9 s
Dimensions (Ø x H)	mm	30 x 70	50 x 70
Rated voltage	V	12	
Power consumption, light fixture	W	< 1	
Power consumption, set	W	2	
Light flux	lm	8	10
Protection class		IP 68	
Power cable length	m	10.00	
Net weight	kg	0.60	0.76
Guarantee*G	Years	2	
Connections, inlet		¾"	1"
Illuminant type		LED	
Number of individual LEDs	Unit	6	9
Light colour		Neutral-white	
Half peak angle	Degrees	30	
Item no. (GB-Version)		50381	50384
Item no.		50114	50115



Extras

Top 3 product characteristics

- LED underwater spotlight with warm white light – now even brighter
- Energy efficient
- Broad half peak angle, ideal for illuminating plants and other features in the pond and garden

Recommendation

For an optimal result, always illuminate plants from top to bottom.

LUNAQUA CLASSIC LED

The all-rounder – underwater and above the water

- LED underwater spotlights for pleasant warm white light accents
- Suitable for use underwater and above the water
- Suitable for permanent underwater use (protection class IP 68)
- Particularly energy efficient with only 1 watt power consumption (multi LED)
- Adjustable head for flexible alignment of the beam angle

TECHNICAL DATA

		LunAqua Classic LED Set 1	LunAqua Classic LED Set 3
Dimensions (Ø x H)	mm	75 x 114	
Rated voltage	V	12	
Power consumption, light fixture	W	1	
Power consumption, set	W	3	5
Light flux	lm	31	
Protection class		IP 68	
Power cable length	m	5.00	
Net weight	kg	1.40	3.10
Guarantee*G	Years	2	
Illuminant type		LED	
Number of individual LEDs	Unit	18	
Light colour		Warm-white	
Half peak angle	Degrees	20	
Not available in GB !			
Item no.		50527	50530

LunAqua Classic LED Set 1



LunAqua Classic LED Set 3



* Only applies for LunAqua Classic LED Set 3



Extras

Top 3 product characteristics

- New: Twice the illumination range
- 3 cold-white or warm-white LED light fixtures, switched in series
- Energy efficient

Recommendation

The LunAqua Mini LEDs are ideal for illumination of fountains, ponds, and pond landscapes, as well as garden and terrace.

LUNAQUA MINI LED

Flexible & decorative power management

- 1 W power LED, available in cold-white and warm-white
- Suitable for use underwater and above the water
- Suitable for permanent underwater use (protection class IP 68)
- Easy to integrate in garden and pond design thanks to the small dimensions
- 3-unit series circuit, incl. 12 V safety transformer
- Ideal for illumination of fountains, ponds, and pond landscapes, as well as garden and terrace
- High-quality stainless steel details
- Adjustable head for flexible alignment



TECHNICAL DATA

		LunAqua Mini LED	LunAqua Mini LED warm
Dimensions (Ø x H)	mm	75 x 110	
Rated voltage	v	220 – 240 V / 50/60 Hz	
Power consumption, light fixture	W	< 1	
Power consumption, set	W	2	
Light flux	lm	46	33
Protection class		IP 68	
Cable length 12 V device	m	2.00 (power unit) + 3.00	
Cable length between spotlights	m	1.50	
Net weight	kg	2.00	
Guarantee* ^{CG} (+ request guarantee)	Years	3 + 2	
Illuminant type		LED	
Number of individual LEDs	Unit	1	
Light colour		Neutral-white	Warm-white
Half peak angle	Degrees	30	
Item no. (GB-Version)		50514	50515
Item no.		50512	50513





Extras



Top 3 product characteristics

- Energy efficient, warm white 3 W power LED
- Flexible in-ground / on-ground installation and on-wall installation
- An additional spotlight (LunAqua Maxi LED Solo) can be retrofitted in each case

Recommendation

Thanks to the interchangeable optics, the half peak angle can be quickly and easily changed from 10° to 30°, to optimally illuminate the garden and pond.

LUNAQUA MAXI LED

Stainless steel design and flexible functionality

- Warm white 3 W power LED in 1-unit or 3-unit set
- Suitable for use underwater and above the water
- Suitable for permanent underwater use (protection class IP 68)
- An additional LunAqua Maxi Solo spotlight can be retrofitted in each case
- Incl. interchangeable optics for a half peak angle of 10° or 30°
- Wall mount and in-ground installation possible
- Incl. ground stake and tool for wall mounting
- Star circuit and robust rubber cable

TECHNICAL DATA

		LunAqua Maxi LED Solo	LunAqua Maxi Set 1	LunAqua Maxi Set 3
Dimensions (Ø x H)	mm	52 x 117		
Rated voltage	V	220 – 240 V / 50/60 Hz		
Power consumption, light fixture	W	3		
Power consumption, set	W	–	5	13
Light flux	lm	61		
Protection class		IP 68		
Cable length 12 V device	m	2.00 (power unit) + 5.00		
Net weight	kg	1.20	1.80	4.20
Guarantee*G (+ request guarantee)	Years	3 + 2		
Illuminant type		LED		
Number of individual LEDs	Unit	1		
Light colour		Warm-white		
Half peak angle	Degrees	30		
Item no. (GB-Version)		–	50510	Not available in GB !
Item no.		50509	50507	50508



Reliable power management: Offering you the best power supply, always and anywhere!

The technology in the pond, such as pumps, filters, and UVC clarifiers, as well as the illumination in the garden would be impossible without the appropriate power supply. OASE InScenio power management offers the possibility of connecting up to four devices simultaneously. These devices are controlled via remote control with total comfort and convenience – even at distances of up to 80 m. With the splash guard protecting the power outlets, functionality and safety

are guaranteed in any wind and weather. Those who prefer to relax in nature or the allotment garden where they must get by without mains power can rely 100 % on the OASE solar products. The heart of the system is a solar module that converts solar energy into usable power. Thanks to a storage module, power supply to the matching fountain pump and light fixture is available even when the sky is overcast.





POWER MANAGEMENT & SOLAR COMPONENTS

The **INSCENIO FM-MASTER 3** is a small multi-talent. Of its 4 connectible power outlets not only are 2 switchable by remote control, but an additional power outlet is also dimmable, for connection of a fountain pump, for example.



The **SOLARSAFE 41** as storage and control unit promises reliable power supply of the other solar devices, even in bad weather.



Tip!

The InScenio Rock sand cover in a near-natural rock design fits naturally in the garden and serves as a splash guard thanks the weather-resistant and robust material. Additional information is provided on page 222.



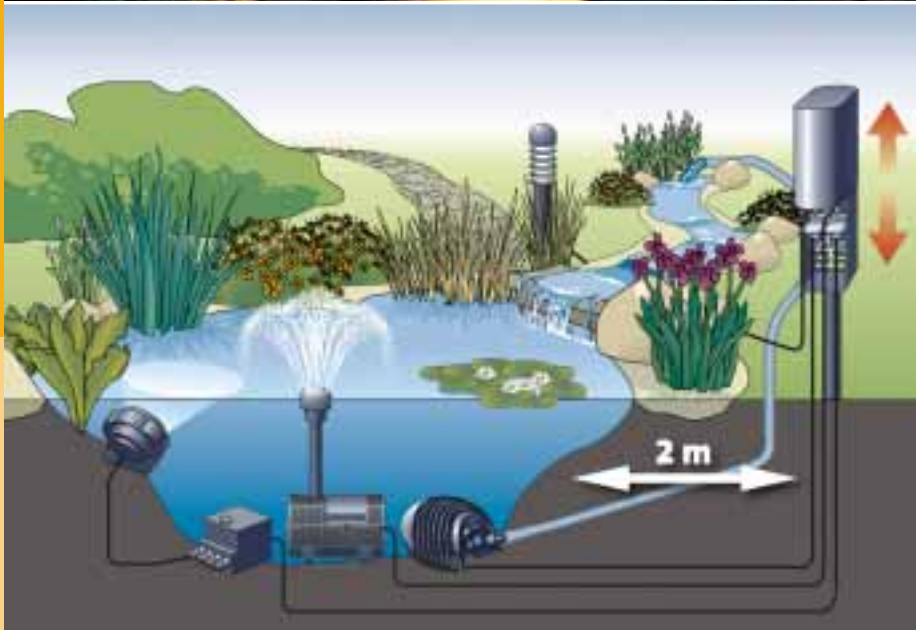

Schematic diagram: Connection possibilities with the OASE InScenio garden outlets



INSCENIO

Flexible & decorative power management

Cover in sandstone-effect
InScenio Rock cover in stone décor elegantly conceals the technical unit. (optional accessory)



Splash guard
For your safety the InScenio cover protects the electronic components from splashing water.



Main module
Example – InScenio FM-Master 3 offers four power outlets of which two can be switched on and off. One input offers permanent power and one a dim function.



Remote control
From a range of up to 80 metres all functions can be easily and conveniently activated.



- Clever power connection system for the complete garden
- Extremely easy and flexible installation, no digging whatsoever
- Retroactive extension is possible at any time
- Year-round use thanks to splash-proof and strain-relieved power outlets
- Ground stake guarantees secure anchoring in the ground

From InScenio FM-Master 1

- Remote control range of the FM-Master to max. 80 m if there is no transmission interference

PRODUCT DETAILS



Strain relief

Strain-relieved outlets are specially protected against mechanical stress and perfect for safe, year-round use.



Splash guard

To be on the safe side: The InScenio cover protects the electronic parts from splashing water. In addition, with the optional InScenio Rock cover the InScenio can be ideally integrated in the garden world.



Ground stake

The ground stake for easy installation without digging and secure anchoring in the ground, is included in the scope of delivery.



Remote control

The remote control unit of the FM Master included in the scope of delivery, and of the FM-ProfiMaster, has a range of up to 80 m, (if there is no transmission interference).

Extras

Top 3 product characteristics

- Flexible modular system
- Easy installation, can also be retro-actively extended
- Protective cover protects against splashing water and mechanical stress

Accessories

InScenio Rock
Cover in rock-effect suitable for all InScenio FM-Master housings.
Item no. 50417 (Page 222)



TECHNICAL DATA

		InScenio Dimmers	InScenio 230	InScenio FM-Master 1	InScenio FM-Master 2	InScenio FM-Master 3	InScenio FM-ProfiMaster
Dimensions (L x W x H)	mm	80 x 60 x 130	215 x 155 x 295				
Rated voltage		220–240 V / 50 Hz					
Max. total load power	W	300	3600				
Max. total load current	A	1.3	16.0				
Net weight	kg	0.20	1.40	1.50	1.70	1.80	1.90
Guarantee* ^G	Years	2					3
Hand-held transmitter / range max.	m	–	80.00				
Permanent power outlets	Unit	–	4 x 230 V	2 x 220–240 V	1 x 220–240 V		–
Power outlets on/off, max. 2000 W	Unit	–	–	2 x 220–240 V	3 x 220–240 V	2 x 220–240 V	
Power outlets, dimmable	Unit	1 x max. 30–300 W	–			1 x max. 40–320 W	1 x max. 1250 W***
Item no. (GB-Version)		Not available in GB !				56473	Not available in GB !
Item no.		51160	55433	54978	36310	36311	56886



* Only InScenio FM-ProfiMaster

** Except InScenio Dimmer

*** Max. 1 pump connection



Schematic diagram: Interaction of the different solar components

SOLAR COMPONENTS

Use new energies – and not only for the good of the environment

Extras

Top 3 product characteristics

- Holistic solar system with matched components
- Easy installation thanks to convenient plug connection
- Off-grid power supply for incredible flexibility

Recommendation

With a full battery the SolarSafe 41 enables solar operation of the Aquarius Solar 700/1500 for up to 17 hours or 8 hours, even without sunlight. The devices can then be used day and night, and even in poor weather conditions.

- The solution is as elegant as it is simple for allotment gardens and other locations without a power supply
- High-quality optimally matched components: Solar cell, storage and control unit, fountain pump and illumination
- Extremely robust and convenient plug connections for all components ensure safe and fast installation
- The items operate even in poor light conditions thanks to the SolarSafe electronically regulated storage and control unit (optional)

SOLARMODULE 35 *Solar cell for power generation*

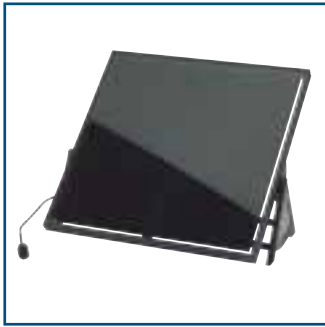

- Extremely high efficiency levels
- Compact dimensions, high impact resistance and break resistance, long service life and convincing aesthetics
- With stand, 10 m power cable and special plugs for connecting to the other OASE solar devices

		SolarModule 35
Dimensions (L x W x H)	mm	600 x 40 x 600
Power cable length	m	10.00
Net weight	kg	8.00
Guarantee* ^G	Years	2
Setup type		Dry installation only
Stockist PU	Unit	1
Not available in GB !		
Item no.		37105

AQUARIUS SOLAR 700 / 1500 *Fountain for solar operation (see also page 52)*



- Connection to the optional Solar Module 35 or to the optional OASE SolarSafe 41 storage and control unit
- Ideal for locations without power supply
- The detachable filter wings can be placed in the bank area
- Telescopic pipe extension with integrated swivel head for individual alignment of the fountain
- 3 fountain attachments included in the scope of delivery

		Aquarius Solar 700	Aquarius Solar 1500
Dimensions (L x W x H)	mm	217 x 130 x 134	
Rated voltage	V	12	
Power consumption	W	8	17
Power cable length	m	5.00	
Net weight	kg	1.40	1.70
Guarantee* ^G (+ request guarantee)	Years	3 + 2	
Max. flow rate	l/min	12	25
Max. flow rate	l/h	700	1500
Max. head height	m	2.00	3.00
Connection, pressure side + for hoses		½"	
Connection, suction-side		¾", 1"	
Filter intake surface	cm²	825	
Quantity nozzles	Unit	3	
Telescopic nozzle extension	cm	16 – 29	
Setup type		Underwater installation only	
Not available in GB !			
Item no.		56888	56889

SOLARSAFE 41 *Storage and control unit for OASE solar power system*



- Optimally matched electronics ensure constant and uniform power to the pumps and lights
- The 12 V solar battery is charged with excess solar energy while the solar modules are in operation
- Connection possibility for up to 2 solar modules, and a maximum of 3 devices
- Indicator light shows charge status

		SolarSafe 41
Dimensions (L x W x H)	mm	360 x 360 x 270
Net weight	kg	16.5
Guarantee* ^G	Years	2
Setup type		Dry installation only
Not available in GB !		
Item no.		56896

LUNAQUA SOLAR *Impressive light effects underwater and above water*



- DC operated LED spotlight with bright white diodes and attractive coloured lens set (red, orange, green, blue)
- Low energy consumption
- Can be used underwater and above water
- Easy mounting with ground stake, wall/ground bracket, and spotlight base, as well as nozzle holder for fastening, e.g. on a fountain

		LunAqua Solar
Dimensions (Ø x H)	mm	85 x 110
Rated voltage	V	12
Power consumption	W	3
Power cable length	m	5.00
Net weight	kg	1.30
Guarantee* ^G	Years	3
Setup type		Can be setup underwater & dry
Not available in GB !		
Item no.		56894

POND CONSTRUCTION & DECORATION

Pond construction

- 200 »Pond planning & implementation«
- 202 Creating garden ponds
- 204 Fleece & liner
- 207 Pond construction accessories
- 208 Pond plant accessories
- 210 Hoses & connectors
- 212 Pump accessories
- 213 Filter accessories
- 214 Filter- /light /power accessories
- 215 Water spouts & pond figures
- 216 Preformed ponds PE
- 217 Preformed ponds Stonecor
- 220 Watercourse elements
- 222 Decorative rock covers
- 223 Water reservoir



POND CONSTRUCTION MATERIAL: HIGH-QUALITY FOR LONG-LASTING ENJOYMENT OF THE POND

With the extensive pond construction product range, construction of your pond is surprisingly easy. The well-designed program makes OASE the perfect pond partner.

Any type of pond is a genuine natural experience and lends the garden a very special, individual highlight. Starting with the smallest pools to larger liner ponds

with fish, to large swim ponds – for every pond OASE has the ideal construction concept with the right material at hand. The advantage of a preformed pond is the easy installation with integrated plant zones, for different pond sizes and shapes the first-class and flexible OASE pond liners AlfaFol PVC, and OaseFol EPDM are well

*»Pond construction
can be so easy!«*

**A reliable liner
assortment for
construction of
your pond!**

suited. The previously cut-to-size PVC liner sections with which you can find the right size of pond liner are very convenient. You can rely on the high-quality, tested and long lasting quality of our pond liners – with a guarantee*^G of up to 20 years! The pond liners are supplemented with an extensive, well thought-out, optimised line of fleece

and accessories. All connections for filter and power fit perfectly together and can be inconspicuously integrated in the garden. With additional information material and building instructions available as film and brochure, you can rely on OASE as your pond construction partner!